

SEYAJ

MADANI TRADING & SERVICE WLL

شركة سياج معدني للتجارة و الخدمات

HIGH QUALITY
FENCING SYSTEMS



SEYAJ
MADANI TRADING & SERVICE WLL

شركة سياج معدني للتجارة و الخدمات

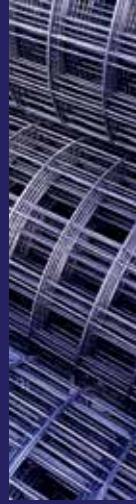

CONTENT

- WHO WE ARE **4**
- OUR PRODUCTS & SERVICES **6**
- METAL FENCING COATING **7**
- OUR MANUFACTURING PROCESS **8**
- TRAFFIC CONTROL FENCING **11**
- HIGH AND ULTRA HIGH SECURITY FENCE **14**
- WELDED - MESH FENCING **18**
- CHAIN LINK FENCING **20**
- CRASH BARRIERS **24**
- PALISADE FENCING **26**
- MOBILE / TEMPORARY FENCING & CROWD CONTROL BARRIERS **28**
- STEEL FABRICATED FENCE **30**
- FARM / DESERT FENCING **32**
- GATES **34**
- GABION SOLUTIONS **38**
- OTHER PRODUCTS **39**

WHO WE ARE?

With years of experience within the fencing industry, here at SEYAJ MADANI TRADING & SERVICES WLL, we have worked hard to build up a strong reputation. Having become renowned within the industry as being one of the subsidiaries of CHAINLINK INDUSTRIES OF QATAR WLL, we have had the pleasure to be involved with most of the prestigious projects in QATAR.

OUR CLIENTS

We have supplied and installed fencing for a wide range of clients, including local authorities and Projects.



INNOVATION

SECURITY

QUALITY

EXPERIENCE

We continuously improve
our market share at this
respectful lands.

OUR PRODUCTS AND SERVICES

As a hardworking and transparent company with strong ethics, you can have peace of mind knowing that you are only working with the best. As an innovative and respectful company, SEYAJ offers the following services:

HIGH-SECURITY FENCING	WELDED MESH PEDESTRIAN FENCING
CHAIN LINK FENCING	PALISADE FENCING
MOBILE / TEMPORARY FENCING	RAIL FENCING
FARM/DESERT FENCING	GATES
GABION SOLUTIONS	CRASH BARRIERS

We pride ourselves on our expertise and we're dedicated to providing excellent service, quality products and competitive prices.

Seyaj, installation teams and manufacturing staff are expertly trained to deliver the high level of workmanship provided from our main company Chainlink Industries of Qatar.



METAL FENCES COATING

Fences will be used to protect a parcel, delimitate a property or secure an area. Whatever it is, they need to withstand corrosion or any other exposure wherever they are placed. Therefore, long lasting protection become key.









Ornamental, welded mesh, chain link or any kind of fence type, each one brings its complexity for a coating process. We provide the adequate coating for all the different types of environment your fence could be subject to and the style of metal fence you use

Polyester Powder Or Thermo Plastic Coating Colours



Our steel fencing and gate designs are supplied galvanized and powder coated to BS EN 13438 in one of our below listed standard colors .

The colors below are always available in our stock. Any other color will be subject to a special surcharge and may be subject to delays which will be notified at the time of estimating.

Polyester Powder Colors

	RAL 1014
	RAL 1035
	RAL 5024
	RAL 6005
	RAL 7011
	RAL 7040
	RAL 9005
	RAL 9006

Thermo Plastic Colors

	RAL 1014
	RAL 6005



OUR MANUFACTURING PROCESS

We have a team of professional craftsmen in the workshop at our premises to ensure that every fence and gate we make is of the highest standard.

As a dedicated fencing contractor, we pride ourselves on providing our clients with a hands-on approach tailored specifically to their individual needs and requirements, offering this flexibility is what sets us apart. The quality of the fences we supply and install has enabled us to work on some large scale and exciting projects over the years.

Whether you are looking to increase your perimeter security, Pedestrian Safety or to keep wildlife out, we're here to provide you with the fencing solution you need.

To find out more about our comprehensive range of fencing services, please get in touch with us. Our experienced team is always available to discuss with you the best options for your perimeter fencing to ensure maximum security and safety at all times.



TRAFFIC CONTROL FENCING

An ideal material for industrial metal wire fencing our welded wire mesh is designed and manufactured to be strong, durable and able to withstand harsh environments.

offers reliable and aesthetic medium-security welded wire mesh with larger apertures...

Pedestrian Guard Rail system guard railing has been purposely designed for use around roads, to keep pedestrians safe or to create a barrier keeping traffic contained to the road. This metal railing is exceptionally strong with solid pales welded to tubular rails but at the same time allows good visibility to road users.

USING AREAS

Roads

Hotels & Resorts

Gas stations and other service stations

Shopping malls and department stores

School parking lots

Parking garage and other allied commercial locations.

Construction and roadwork zones





PEDESTRIAN FENCES AND
SELF LOCKING POSTS SYSTEMS



PEDESTRIAN
GUARD RAILS







HIGH-SECURITY FENCING

Where the application specifically demands a security fence design to meet specifications of High Security, or where a visual design requirement is taken in to consideration, our high security welded mesh system provides an ideal solution for a wide range of high security perimeter needs,

The climb resistant mesh with its small apertures and welds at each intersection eliminate foot and finger holds, prevent objects being passed through and is particularly effective against the use of conventional hand wire cutting tools.

Assets:

- Vandal-resistant: anti-climb and anti-cut
- Secure and discreet
- Efficient deterrence
- Excellent visibility through the fence

USING AREAS

Sensitive areas

Mining and oil zones

Penitentiary areas

Houses and places of residence located in sensitive areas

Consulates, embassies and administrative buildings



PERMANENT ULTRA HIGH SECURITY FENCE

ULTRA Fence is a permanent high security fence for providing long term Permanent high security fence for application in Prisons, Army and Air force camps or installations at high sensitivity, Airports, Oil and Gas field installations, Boundary fence at borders with neighboring countries, water desalination plants, Power plants, Ports, Palaces and diplomatic offices, compounds and residences. Ends are barbed selvage to provide deterrent sharp edges. While minimum recommended height of fence is 2.40 Meters, heights upto 4.0/6.0 meters can be used depending upon sensitivity of the location and threats anticipated, while 300 mm might be provided to bury the fence fabric below ground level, preferably in a continuous concrete beam, to make it scaling proof. Additionally over the fence posts 'V' crank is required, 600 mm each side to place 6 rows of barbed wires and support and fix one continuous concertina Razor tape of diameter 900mm or 1,000mm, which are optional, but makes Ultra Anti Intruder fence. (Specifications of concertina Razor tapes is given in the following pages)

Line Posts should be Minimum 60 mm OD with straining and corner posts 73 or 89 mm OD, to match the fabric color it is recommended to apply Epoxy paint or Powder coat to posts over GI coating as per ASTM Sch 40 Grade A53, in matching grey or silver color.







WELDED-MESH FENCING

An ideal material for industrial metal wire fencing our welded wire mesh is designed and manufactured to be strong, durable and able to withstand harsh environments.

offers reliable and aesthetic medium-security welded wire mesh with larger apertures...

USING AREAS

Industrial Zones
Roads
Commercial Areas
Residential Areas
Park & Gardens

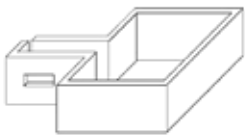
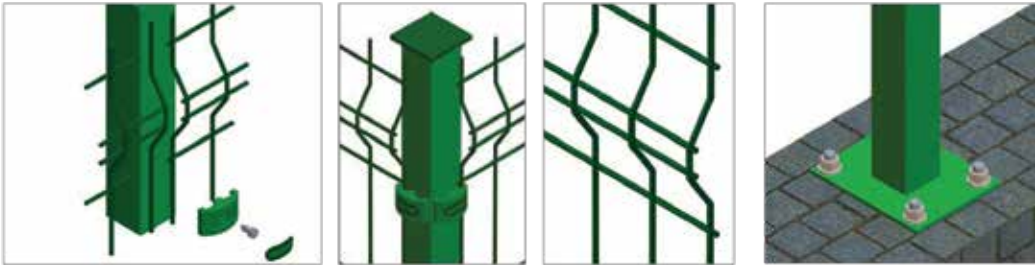

End Clamp

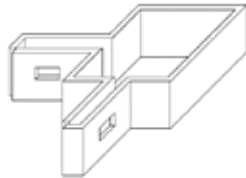

Corner Clamp



Straight Line Clamp





Welded wire mesh fence is extensively used for different heights and sometimes in conjunction with Chain Link fence for dual security. These are also used as decorative fences with polyester powder coating or PVC Coating in green color RAL 6005. Welded fences come in many designs, wire sizes and profiles, used for parking lots, children play grounds, schools, city roadway pedestrian barriers and public parks to prevent intrusion simultaneously providing good aesthetic looks.



Wire diameters have choice of 2.50/3.0/3.76/4.0/5.0/6.0/ 8.0 mm GI Wires, fabrication is done using specialized spot welding machines at every intersection. Welded wire mesh fences can be supplied in any height upto 8.0 meters.

Posts are specially designed steel sections usually in GI or GI & Powder coating or alternatively with PVC coating with plastic caps these can be fixed with base plate on continuous cast concrete beam or grouted to concrete foundation. Fasteners – Panels and posts are assembled together with bolts using flat steel bar, with special steel clamps or clips and self locking bolts and nuts.



CHAIN LINK FENCING

Chain link fence, also known as diamond mesh fence, is a type of woven fence usually made of galvanized or PVC coated steel wire. The wires are woven together to form beautiful diamond patterns. It offers a cost-effective solution for farm and commercial applications. Typically, the shorter heights are commonly selected for farm uses while the taller heights are most often for commercial uses to provide more security. Besides, it is a great option for road, railway, airport fencing, equipment and facilities protection fencing.

Galvanized and green PVC chain link fences are the most popular chain link fence across the world. Other PVC colors are available upon request.

USING AREAS

Industrial Zones

Road Edges

Railways

Airport Fencing

Sports Areas

Zoos & Gardens & Parks





CHAIN LINK FENCING

Chain link fences have a wide range of applications and specifications depend on usage and durability required i.e. temporary or permanent:

- BOUNDARY DEMARCATION FENCE
- SPORT PLAYGROUND FENCE
- CONSTRUCTION SITE FENCE
- SECURITY FENCE
- HIGH SECURITY FENCE
- HIGHWAY SAFETY FENCE
- DOG KENNEL FENCE
- ZOOLOGICAL PARK FENCE
- BIRD CAGE FENCE











WIRE SIZEZ

						
GI	4,85mm	4mm	3,76mm	3mm	2,5mm	2mm
PVC	4,88mm	4mm	3,76mm	3mm		

MESH SIZEZ

					
60mm	50mm	45mm	40mm	25mm	20mm

CRASH BARRIERS

Seyaj, provider of Alka Barrier products and barrier posts. We provide high quality crash barrier solutions for roads, highways and much more.

The experienced team at Seyaj can help you with all aspects regarding crash barrier solutions.

We stock a wide range of barrier products including crash barrier beams, crash barrier posts, open box beam barriers and more. Operating our own stock management system allows us to offer extremely fast turnaround times, ensuring that the quality of the products that we supply is to the highest standard.

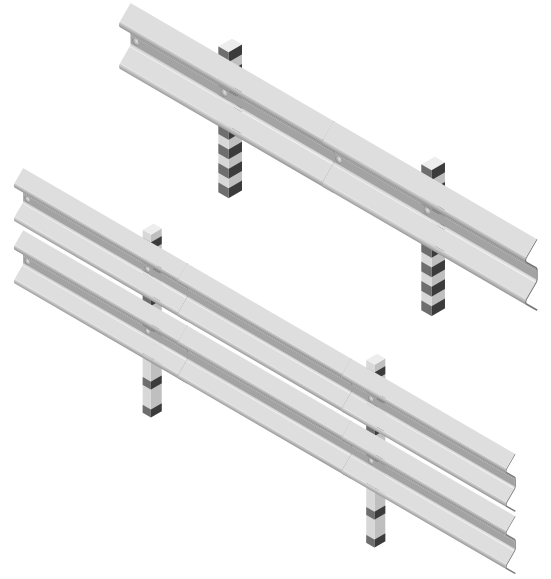

USING AREAS

Roads

Highways



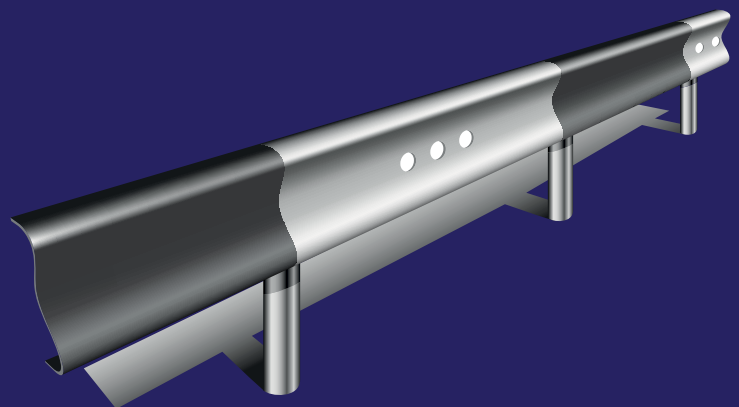

PALISADE FENCING

The security of your property is no doubt a high concern to your business. Palisade fencing is designed to provide a formidable long-lasting barrier against would be intruders. This makes it one of our highly durable fencing options. Made from high quality steel, our palisade fencing is made in a wide range of specifications for differing levels of security needs.

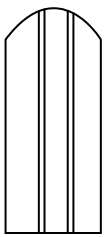

Rounded

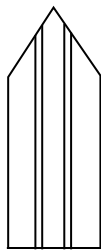

Pointed

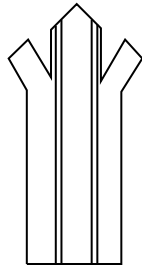

Triple Pointed

USING AREAS

Industrial Units

Utilities Companies

Airports

Highways & Railways

High Security

Powerstations

Dams and Reservoirs

In today world "security" is of paramount importance and in crime and vandalism world over has dictated a need for a security perimeter fence which offers "protection" in terms compared to conventional fences available in market which are not full proof and can easily be tempered with.

Palisade fencing system provides a formidable barrier and is manufactured from cold roll formed steel sections designed to provide strength and rigidity, which offers excellent performance in standard height from 1.2m to 3.60m.

A wide range of specification are available offering a choice of "D" type or "W" type pale section which are offered with a variety of heads chosen by the risk assessment for a particular site.

Palisade fencing is supplied in 2.75m wide panels complete with security fastenings all steel components are pre-fabricated and pre-punched-drilled for speedy on site assembly and erection.

Palisade fence has been widely successfully used the following application as a cost effective means of security fencing. Industrial, power generation stations, electricity substation, gas installations, oil terminals, fuel terminals, military installation, airport perimeters.





MOBILE / TEMPORARY FENCING

Frame panel system with PVC base for temporary protection and control of crowd and vehicles.

Assets:

- Quality and durability
- Flexibility
- Service

USING AREAS

- Construction Sites
- Factory Inner sides
- Crowded Areas
- Events & Festivals
- Airports
- Sport Organizations

CROWD CONTROL BARRIERS

Pedestrian safety should be first and foremost on and around civil projects, work sites, events and festivals. Seyaj's crowd control barriers are quickly and easily erected to form a continuous barrier between pedestrian traffic and possible danger, to provide safety and organization at public events, The crowd control barricades are perfect for helping to guide civilian traffic, ensuring that you keep them safe and restrict people from venturing into restricted areas.

Standard Barriers measure 2000mm x 1000mm and are constructed from galvanized steel. Featuring double interlocking hinge points, this crowd control barrier provides excellent stability. The interlocking hinge system makes installation quick and easy, and panels are designed with or without removable feet that can be taken off during stacking and storing.

Advantages;

- Light but sturdy thanks to feet designs
- Anti-Trip Feet Available
- Rotatable Feet for portability
- Long Lasting - Hot dipped galvanization for durability and all weather use
- Easy to handle - Carry 2 at a time
- Barricades stack within each other for better storage
- 100% recyclable



USING AREAS

- Temporary Walkways
- Public Events
- Landscaping
- Road Work construction
- Utility Works
- Events





STEEL FABRICATED FENCE

RF, Ornamental and Grill metal railings can provide good levels of security without losing the decorative and traditional edge to enhance the exquisiteness of the property and application the railings can be used for roadside fencing, city councils, schools, sporting facilities boundary fencing and security fencing, all available in any powder coated colour of your choice.

USING AREAS

Schools

Roadside Fencing

City Councils

Sporting Facilities

Villas





FARM / DESERT FENCING

Desert fencing system is mainly used as an anti-intrusion barrier against farm and other animals. The most common use is on highways, where vast distances are covered at a very economical cost. Animal fencing can also be used to enclose areas such as farms, desert areas and national parks, where security is not critical. This system is easy to install and can be erected in a comparatively short-time.

USING AREAS

Farms

Desert Areas

National Parks





We supply fixed knot Camel fence for highway security, also called Right of Way (ROW) fence to ensure that cattle and stray camels do not cross at undesigned places, causing serious & fatal road accidents.

Seyaj Trading Camel fence is temper proof, as knots cannot be opened with ordinary tools, posts IP120 & IP 80 are placed 10 meters apart grouted in concrete mix Fence fabric supplied in rolls of 70 or 100 linear Meter lengths, while 200 meter rolls are optional, since bulky to handle. Fence fabric is supplied with pre-stripped roll ends for very easy and fast to erect with less reliance on labor.



Camel fence can be supplied with a choice of 3 optional knots as below; these are manufactured using exclusive & revolutionary machine knot making technology. Each knot design while providing desired security ensures that Camels/ cattle is not bruised, while dashing, leaning or scratching against the fence.



DOUBLE LOCK KNOT

SPIRAL KNOT

X- KNOT

Fence design comprises of 11 rows of horizontal line wires and vertical staywires 50 or 100 mm apart. High tensile top and bottom 3.50 mm line wires together with 9 nos 3mm line wires and 3mm medium tensile stay wires.

GATES

As well as wide range of fencing solutions, Seyaj offers hinged, welded mesh and chain link security gates.

These can be standard swing gates (single or double leaf) and (sliding or cantilever)gates. Gates can be supplied galvanized, PPC (Polyester Powder Coated), TPC (Thermo Plastic Coated) or Epoxy painted only.



USING AREAS

Industrial Buildings

Schools

City Councils

High Security





SWING

We manufacture sturdy heavy duty gates to match the ChainLink fence aesthetically, both single leaf man gates and double leaf vehicle entry gates. Gates are designed of sturdy construction as gates undergo maximum usance, wear and tear, being extensively used and handled.

Gate frame is made of heavy duty construction, using ASTM Sch. 40 GI pipe frame from 48.3/60.3 mm OD Pipes, with 42.3 mm bracing.

SLIDING / CANTILEVER

We offer Sliding gates with Tubular CHS, SHS or RHS sections, infill can be ChainLink fabric, RHS infill or ornamental with sturdy and rugged construction.

ChainLink infill sliding gates are equipped with Teflon wheels and easy to operate manually on concrete surface. While GI steel fabricated gates slide on inverted GI 'L' angles embedded in RCC. Gates are lockable to the end posts using a padlock or electrically operated solenoid lock.

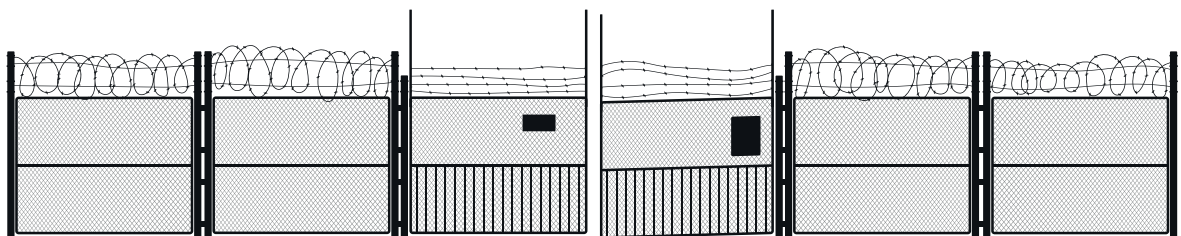
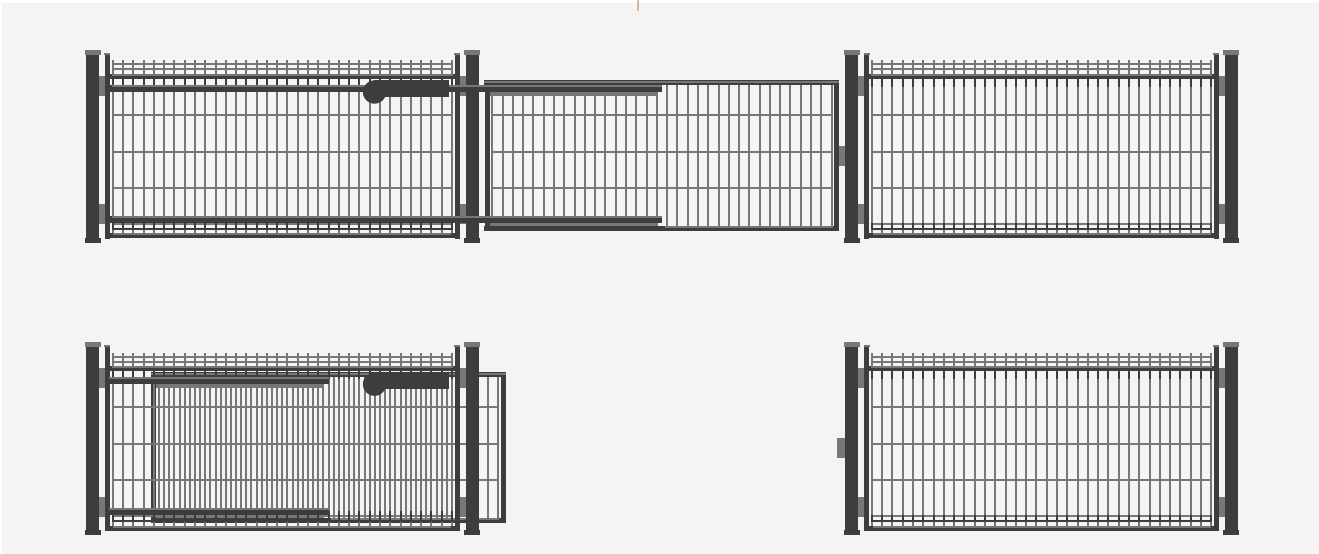



GATES

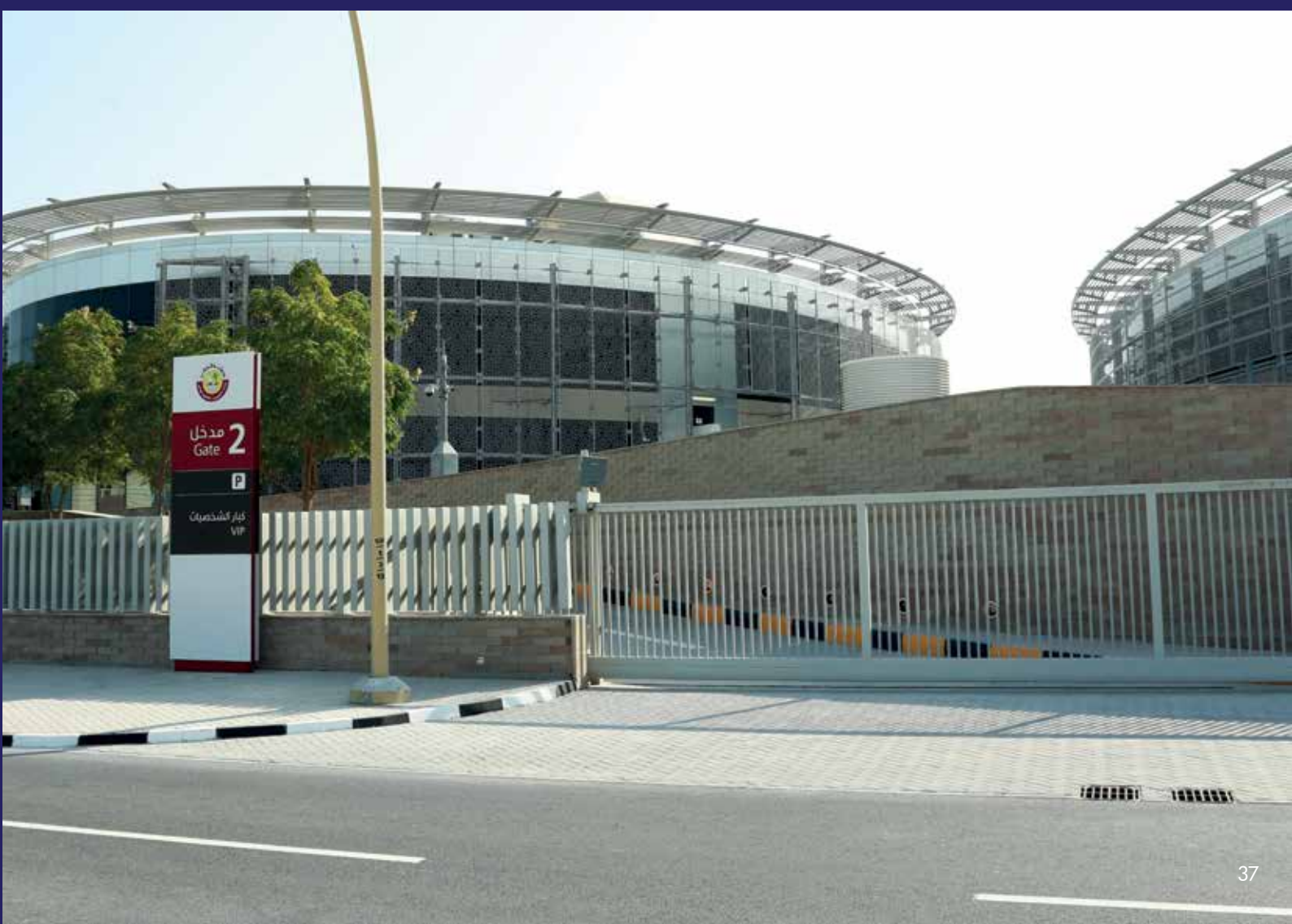

GABION SOLUTIONS

There are numerous uses for these Gabion modular units and are typically used to form flexible, permeable and monolithic structures such as retaining walls, channel linings, hydraulic control structures and erosion protection. They are increasingly being used in architectural applications as well.

USING AREAS

Architectural Cladding

Garden Walls

Retaining Wall



OTHER PRODUCTS



Barbed Wires



Watch Tower



Fixed & Surface Mounted Bollards



Concertina Razor Tape



Stainless Steel Handrails



Pipe Railing System



Glass Balustrade



Stainless Steel Bollards



+974 4451 0413
+974 4451 0417



www.seyaj-tr.com
info@seyaj-tr.com



Economic Zone, BirkatAl Awamer, Zone 91 Street: 3027
Building: 71 PO BOX: 40125 QATAR